

**Signature and Name of Invigilator**

1. (Signature) \_\_\_\_\_  
(Name) \_\_\_\_\_
2. (Signature) \_\_\_\_\_  
(Name) \_\_\_\_\_

OMR Sheet No. : .....  
(To be filled by the Candidate)

Roll No. 

--	--	--	--	--	--	--	--

  
(In figures as per admission card)

Roll No. \_\_\_\_\_  
(In words)

**J 8 8 1 5**

**PAPER - III**

**ELECTRONIC SCIENCE**

[Maximum Marks : 150]

Time : 2½ hours]

Number of Pages in this Booklet : 24

Number of Questions in this Booklet : 75

**Instructions for the Candidates**

- Write your roll number in the space provided on the top of this page.
- This paper consists of seventy five multiple-choice type of questions.
- At the commencement of examination, the question booklet will be given to you. In the first 5 minutes, you are requested to open the booklet and compulsorily examine it as below :
  - To have access to the Question Booklet, tear off the paper seal on the edge of this cover page. Do not accept a booklet without sticker-seal and do not accept an open booklet.
  - Tally the number of pages and number of questions in the booklet with the information printed on the cover page. Faulty booklets due to pages/questions missing or duplicate or not in serial order or any other discrepancy should be got replaced immediately by a correct booklet from the invigilator within the period of 5 minutes. Afterwards, neither the Question Booklet will be replaced nor any extra time will be given.
  - After this verification is over, the Test Booklet Number should be entered on the OMR Sheet and the OMR Sheet Number should be entered on this Test Booklet.
- Each item has four alternative responses marked (1), (2), (3) and (4). You have to darken the circle as indicated below on the correct response against each item.  
**Example :** ① ② ● ④ where (3) is the correct response.
- Your responses to the items are to be indicated in the **OMR Sheet given inside the Booklet only**. If you mark your response at any place other than in the circle in the OMR Sheet, it will not be evaluated.
- Read instructions given inside carefully.
- Rough Work is to be done in the end of this booklet.
- If you write your Name, Roll Number, Phone Number or put any mark on any part of the OMR Sheet, except for the space allotted for the relevant entries, which may disclose your identity, or use abusive language or employ any other unfair means, such as change of response by scratching or using white fluid, you will render yourself liable to disqualification.
- You have to return the original OMR Sheet to the invigilators at the end of the examination compulsorily and must not carry it with you outside the Examination Hall. You are however, allowed to carry original question booklet and duplicate copy of OMR Sheet on conclusion of examination.
- Use only Blue/Black Ball point pen.
- Use of any calculator or log table etc., is prohibited.
- There are no negative marks for incorrect answers.

**परीक्षार्थियों के लिए निर्देश**

- इस पृष्ठ के ऊपर नियत स्थान पर अपना रोल नम्बर लिखिए।
- इस प्रश्न-पत्र में पचहत्तर बहुविकल्पीय प्रश्न हैं।
- परीक्षा प्रारम्भ होने पर, प्रश्न-पुस्तिका आपको दे दी जायेगी। पहले पाँच मिनट आपको प्रश्न-पुस्तिका खोलने तथा उसकी निम्नलिखित जाँच के लिए दिये जायेंगे, जिसकी जाँच आपको अवश्य करनी है :
  - प्रश्न-पुस्तिका खोलने के लिए पुस्तिका पर लगी कागज की सील को फाड़ लें। खुली हुई या बिना स्टीकर-सील की पुस्तिका स्वीकार न करें।
  - कवर पृष्ठ पर छपे निर्देशानुसार प्रश्न-पुस्तिका के पृष्ठ तथा प्रश्नों की संख्या को अच्छी तरह चैक कर लें कि ये पूरे हैं। दोषपूर्ण पुस्तिका जिनमें पृष्ठ/प्रश्न कम हों या दुबारा आ गये हों या सीरियल में न हों अर्थात् किसी भी प्रकार की त्रुटिपूर्ण पुस्तिका स्वीकार न करें तथा उसी समय उसे लौटाकर उसके स्थान पर दूसरी सही प्रश्न-पुस्तिका ले लें। इसके लिए आपको पाँच मिनट दिये जायेंगे। उसके बाद न तो आपकी प्रश्न-पुस्तिका वापस ली जायेगी और न ही आपको अतिरिक्त समय दिया जायेगा।
  - इस जाँच के बाद प्रश्न-पुस्तिका का नंबर OMR पत्रक पर अंकित करें और OMR पत्रक का नंबर इस प्रश्न-पुस्तिका पर अंकित कर दें।
- प्रत्येक प्रश्न के लिए चार उत्तर विकल्प (1), (2), (3) तथा (4) दिये गये हैं। आपको सही उत्तर के वृत्त को पेन से भरकर काला करना है जैसा कि नीचे दिखाया गया है।  
**उदाहरण :** ① ② ● ④ जबकि (3) सही उत्तर है।
- प्रश्नों के उत्तर केवल प्रश्न पुस्तिका के अन्दर दिये गये OMR पत्रक पर ही अंकित करने हैं। यदि आप OMR पत्रक पर दिये गये वृत्त के अलावा किसी अन्य स्थान पर उत्तर चिह्नंकित करते हैं, तो उसका मूल्यांकन नहीं होगा।
- अन्दर दिये गये निर्देशों को ध्यानपूर्वक पढ़ें।
- कच्चा काम (Rough Work) इस पुस्तिका के अन्तिम पृष्ठ पर करें।
- यदि आप OMR पत्रक पर नियत स्थान के अलावा अपना नाम, रोल नम्बर, फोन नम्बर या कोई भी ऐसा चिह्न जिससे आपकी पहचान हो सके, अंकित करते हैं अथवा अभद्र भाषा का प्रयोग करते हैं, या कोई अन्य अनुचित साधन का प्रयोग करते हैं, जैसे कि अंकित किये गये उत्तर को मिटाना या सफेद स्याही से बदलना तो परीक्षा के लिये अयोग्य घोषित किये जा सकते हैं।
- आपको परीक्षा समाप्त होने पर मूल OMR पत्रक निरीक्षक महोदय को लौटाना आवश्यक है और परीक्षा समाप्ति के बाद उसे अपने साथ परीक्षा भवन से बाहर न लेकर जायें। हालाँकि आप परीक्षा समाप्ति पर मूल प्रश्न-पुस्तिका तथा OMR पत्रक की डुप्लीकेट प्रति अपने साथ ले जा सकते हैं।
- केवल नीले/काले बाल प्वाइंट पेन का ही इस्तेमाल करें।
- किसी भी प्रकार का संगणक (कैलकुलेटर) या लाग टेबल आदि का प्रयोग वर्जित है।
- गलत उत्तरों के लिए कोई नकारात्मक अंक नहीं हैं।



## ELECTRONIC SCIENCE

### PAPER - III

**Note :** This paper contains **seventy five (75)** objective type questions of **two (2)** marks each. **All** questions are **compulsory**.

1. The 6 V zener diode shown in figure has zero zener resistance and a knee current of 5 mA. The minimum value of R so that the voltage across it does not fall below 6 V is :

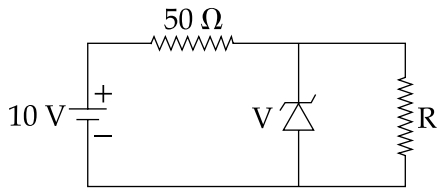

- (1) 1.2 k $\Omega$                       (2) 80  $\Omega$                       (3) 50  $\Omega$                       (4) zero  $\Omega$
2. While measuring the output impedance of an amplifier, the input is replaced by the internal impedance of the source because in this measurement :
- (1) no signal should be transferred from input to output  
(2) an impedance matching between output and input should take place  
(3) input impedance should not be zero  
(4) None of the above
3. What is the name of adhesion promoter used in case of positive photo resist ?
- (1) Hexa Methyl Di Silane                      (2) Hexa Methane Di Silane  
(3) Hexa Methyl Di Silicoxyl                      (4) Hexa Methane Di Silicon
4. Consider following program for 8085 microprocessor :
- ```
MVI A, 32H
RRC
RRC
```
- The contents of A after execution of program will be :
- (1) 08H                      (2) 8CH                      (3) 12H                      (4) None of these



5. An interrupt in which the external device supplies its address as well as the interrupt request is known as :

- (1) Vectored interrupt                      (2) Maskable interrupt  
(3) Non - maskable interrupt              (4) All of these

6. EPROM stands for :

- (1) Erasable Programmable Read Only Memory  
(2) Electrically Programmable Read Write Memory  
(3) Electrically Programmable Read Only Memory  
(4) None of these

7. Let the magnitude of the gain in the inverting Op-Amp amplifier circuit shown in the figure be  $x$  with switch  $S_1$  open. When the switch  $S_1$  is closed, the magnitude of the gain becomes :

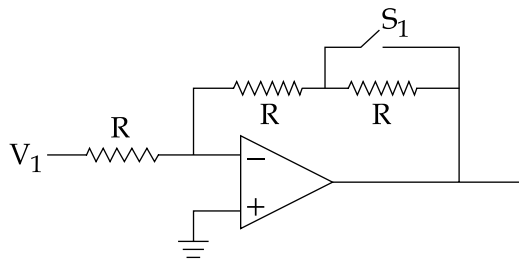

- (1)  $\frac{x}{2}$                       (2)  $-x$                       (3)  $2x$                       (4)  $-2x$

8. A half wave rectifier operates from 50 Hz supply and provides a peak output voltage of 60 V across the  $600 \Omega$  resistance. The value of capacitance for the capacitor filter would limit the peak to peak ripple voltage across load is 15 V :

- (1)  $100 \mu\text{F}$                       (2)  $117 \mu\text{F}$                       (3)  $117 \text{ F}$                       (4)  $0 \text{ F}$



9.

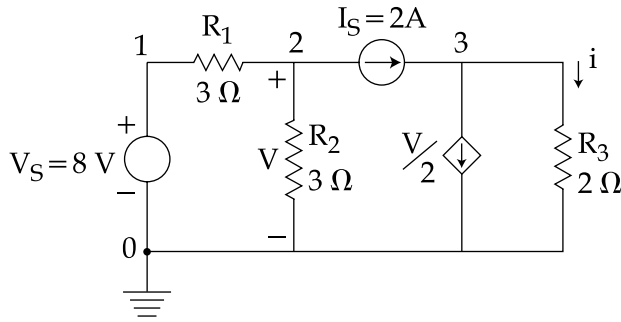

Find the value of  $i$  using the above circuit by making use of the superposition theorem.

- (1) 1 A                      (2) 1.5 A                      (3) 2 A                      (4) 0.5 A

10.

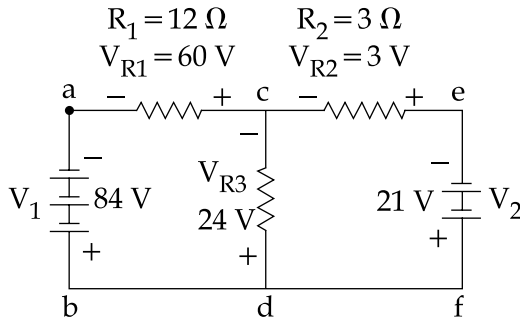

In the above mentioned figure, how much is the voltage around partial loop  $cefd$  and how much is the voltage around loop  $cefdc$  ?

- (1) 24V ; 0V                      (2) 24V ; 24V                      (3) 0V ; 24V                      (4) -24V ; 0V

11. In a certain FET circuit,  $V_{GS} = 0V$ ,  $V_{DD} = 15V$ ,  $I_{DSS} = 15 \text{ mA}$ , and  $R_D = 470\Omega$ . If  $R_D$  is decreased to  $330 \Omega$ ,  $I_{DSS}$  is :

- (1) 19.5 mA                      (2) 10.5 mA                      (3) 15 mA                      (4) 1 mA

12. A certain inverting amplifier has a closed - loop gain of 25. The op-amp has an open - loop gain of 1,00,000. If another op-amp with an open-loop gain of 2,00,000 is substituted in the configuration, the closed loop gain :

- (1) doubles                      (2) drops to 12.5                      (3) remains at 25                      (4) increases slightly



13. In C++ Programming language, what is the scope of the variable declared in the user defined function ?

- (1) Whole Program (2) Only inside { } block  
 (3) Only outside { } block (4) None of the above

14. The FORTRAN statement for the polynomial  $5x^4 + 3x^3 + 2x^2 + x + 10$  is :

- (1)  $10. + x*(1. + x*(2. + x*(3. + 5. *x)))$   
 (2)  $10 + x*(1 + x*(2 + x*(3 + 5*x)))$   
 (3)  $5.x*x*x*x + 3.x*x*x + 2.x*x + x + 10.$   
 (4)  $5*x*x*x*x + 3*x*x*x + 2*x*x*x + 10$

15. Which of the following concepts provides facility of using object of one class inside another class ?

- (1) Encapsulation (2) Abstraction (3) Composition (4) Inheritance

16. The circuit given below uses TTL gates. The current I is found to be 1.6 mA when B is held at logic 1. If B is connected to A instead of being at logic - 1, the current I will be :

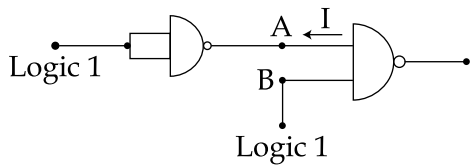

- (1) 0 (2) 0.8 mA (3) 1.6 mA (4) 3.2 mA

17. The minimized expression for the K - Map given below is :

|    |    |    |    |    |
|----|----|----|----|----|
|    | AB |    |    |    |
| CD | 00 | 01 | 11 | 10 |
| 00 |    | 1  | X  |    |
| 01 |    |    | X  |    |
| 11 | 1  | 1  | X  | X  |
| 10 | 1  |    | X  | X  |

- (1)  $\bar{A} B \bar{C} \bar{D} + \bar{A} C D + \bar{A} \bar{B} C \bar{D}$  (2)  $\bar{A} B \bar{C} \bar{D} + \bar{A} C D + \bar{A} B C$   
 (3)  $B \bar{C} \bar{D} + C D + \bar{A} B C$  (4)  $B \bar{C} \bar{D} + C D + \bar{B} C$

18. An analog voltage in the range 0 to V volts is to be converted into 3 bit digital output. It is divided into eight intervals. The top and bottom intervals are  $\frac{V}{14}$  and the middle six intervals are  $\frac{V}{7}$ . The maximum quantization error will be :
- (1) 0                      (2)  $\frac{V}{7}$                       (3)  $\frac{V}{14}$                       (4) V
19. A dipole antenna has a radiation resistance of  $67 \Omega$  and has a loss resistance of  $5 \Omega$  measured at the feed point. The efficiency of dipole antenna is :
- (1) 93%                      (2) 7.4%                      (3) 69%                      (4) 74%
20. A car has an FM antenna having field strength of  $\bar{E} = 80 \cos(6.277 \times 10^8 t - 2.092 y) \hat{a}_z$  V/m the value of  $\epsilon_0 = 8.86 \times 10^{-12}$  F/m. The amplitude of the displacement current density near the antenna is given by :
- (1) 1.257 A/m<sup>2</sup>              (2) 0.445 A/m<sup>2</sup>              (3) 12.57 A/m<sup>2</sup>              (4) 44.5 A/m<sup>2</sup>
21. A load commutated chopper fed d.c. drive uses 100 V d.c. supply. The maximum chopper frequency is 5 kHz. The value of maximum load current is 100 A. The commutating capacitance will be :
- (1) 100  $\mu$ F                      (2) 80  $\mu$ F                      (3) 50  $\mu$ F                      (4) 200  $\mu$ F
22. The reading of an ac ammeter connected to a half controlled rectifier with firing angle  $\alpha = 0$  will be :
- (1)  $\frac{I_m}{2}$                       (2)  $\frac{I_m}{\sqrt{2}}$                       (3)  $\sqrt{2} I_m$                       (4)  $\frac{I_m}{2 \pi}$



23. A graded index fiber has a core with parabolic refractive index profile which has a diameter of 50  $\mu\text{m}$ . The fiber has a numerical aperture of 0.2, the operating wavelength is 1  $\mu\text{m}$ . The total number of guided modes are :

- (1) 147                      (2) 247                      (3) 347                      (4) 447

24. In linearly polarized modes traversing in the optical fibers the  $LP_{01}$  is exactly equal to :

- (1)  $H_{21}$ ,  $TE_{01}$  and  $TM_{01}$                       (2)  $HE_{11}$   
 (3)  $H_{12}$                       (4)  $HE_{22}$ ,  $TE_{02}$

25. A mixer stage has a noise figure of 20 dB and is preceded by an amplifier that has a noise figure of 9 dB and an available power gain of 15 dB. The overall noise figure is :

- (1) 9.44 dB                      (2) 11.44 dB                      (3) 10.44 dB                      (4) 11.07 dB

26. The density function of a random variable is given by  $p(x) = Ke^{-\frac{x^2}{2}}$  for  $-\infty < x < \infty$ . The value of K should be :

- (1)  $\sqrt{\frac{2}{\pi}}$                       (2)  $\frac{1}{\sqrt{2\pi}}$                       (3)  $\frac{1}{2\sqrt{\pi}}$                       (4)  $\frac{1}{\pi\sqrt{2}}$

27. A full duplex operation permits the transmission :

- (1) In both directions at the same time  
 (2) In only one direction at one time  
 (3) In both directions at different times  
 (4) In only one direction at all times

28. The open loop transfer function of a system is  $\frac{K(1+S)}{(1-S)}$ . The Nyquist plot for the system is :

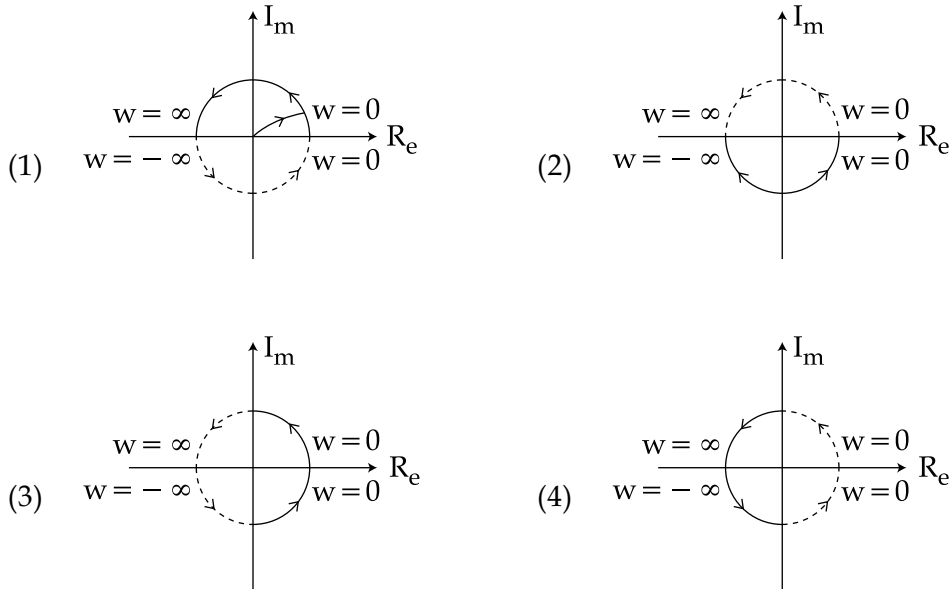

29. The rotational movement for the wiper in the case of the carbon track potentiometer is given by  $\theta_t$  degrees. The output is taken at an angle  $\theta_0$ . The sensitivity of the device will be :

- (1)  $\frac{1}{\theta_t}$                       (2)  $\frac{1}{\theta_0}$                       (3)  $\frac{\theta_0}{\theta_t}$                       (4)  $\frac{\theta_t}{\theta_0}$

30. The mass - spring - damper system shown in the following figure represents :

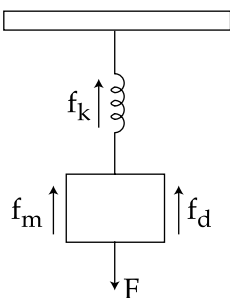

- (1) a zero - order system                      (2) a first - order system  
 (3) a second - order system                      (4) a third - order system



31. Energy bands of a material is decided by :

- (a) The atomic number
- (b) Relative spacing of atoms in the solids
- (c) Melting point of the material
- (d) Hardness of the material

Which of the following is **correct** ?

- (1) (a), (c)                      (2) (b), (c)                      (3) (a), (b)                      (4) (c), (d)

32. Which of the following materials is not a semiconductor ?

- (a) ZnO
- (b) Carbon nanotube
- (c) SiO<sub>2</sub>
- (d) Copper

Which is **correct** ?

- (1) (a), (b)                      (2) (b), (c)                      (3) (c), (d)                      (4) (a), (c)

33. In 8086 microprocessor which is true ?

- (a) Coprocessor is interfaced in MAX mode
- (b) Coprocessor is interfaced in MIN mode
- (c) I/O can be interfaced in MAX/MIN mode
- (d) Supports pipelining

**Options :**

- (1) (a), (b)                      (2) (a), (c), (d)  
(3) (c), (d)                      (4) (b), (d)

34.  $\overline{\text{BHE}}$  of 8086 microprocessor signal is **not** used to interface the :

- (a) Even Bank Memory                      (b) Odd Bank Memory
- (c) I/O                      (d) DMA

Which of the above referred statements are **correct** ?

- (1) (a), (c), (d)                      (2) (b), (d)  
(3) (a), (d)                      (4) (b), (c)



35. As per Tellegan's theorem of Network analysis, which of the below mentioned statements are **true** ?

- (a) Power factor is cosine of the phase angle between applied voltage and current drawn from the supply voltage.
- (b) Power factor is sine of the phase angle between applied voltage and current drawn from the supply voltage.
- (c) Power in the AC circuit is given by  $V \times I \cos \phi$
- (d) Power in the AC circuit is given by  $\frac{I^2}{V}$

**Options :**

- (1) (a) and (c) are correct
- (2) (b) and (c) are correct
- (3) (a) and (d) are correct
- (4) (b) and (d) are correct

36. A band pass filter response has :

- (a) Two critical frequencies
- (b) Quality factor depends on the center frequency and the bandwidth
- (c) Quality factor depends on the critical frequencies
- (d) A voltage gain

**Options :**

- (1) (a) and (b) are correct
- (2) (a) and (c) are correct
- (3) (b) and (d) are correct
- (4) (c) and (d) are correct

37. In a RC- coupled common emitter amplifier :

- (a) Coupling capacitance affects the low frequency response
- (b) Bypass capacitance affects the low frequency response
- (c) Coupling capacitance affects the high frequency response
- (d) Bypass capacitance affects the high frequency response.

**Options :**

- (1) (a) and (b) are correct
- (2) (a) and (d) are correct
- (3) (b) and (d) are correct
- (4) (c) and (d) are correct



38. The following are **true** with respect of Common Mode Rejection ratio of a practical Op-Amp :

(a) Value is given by  $20 \log_{10} \left( \frac{A_{\text{com}}}{A_{\text{diff}}} \right)$

(b) Value is given by  $20 \log_{10} \left( \frac{A_{\text{diff}}}{A_{\text{com}}} \right)$

(c) Value is  $\infty$

(d) Value is around 100 dB

**Options :**

(1) (a) and (c) are true

(2) (b) and (c) are true

(3) (a) and (d) are true

(4) (b) and (d) are true

39. Following are the transmission mediums :

(a) Twisted pair (b) Microwaves (c) Coaxial cable (d) Optical fiber

Arrange these in the descending order of their Bandwidth :

(1) (d), (c), (a), (b) (2) (d), (b), (c), (a) (3) (a), (b), (c), (d) (4) (b), (c), (a), (d)

40. Following are the microwave bands :

(a) X

(b) ku

(c) V

(d) Q

Arrange these in the order of increasing frequency :

(1) (a), (c), (b), (d)

(2) (d), (a), (b), (c)

(3) (a), (b), (c), (d)

(4) (a), (b), (d), (c)

41. In a lossless buck converter, an average power of 20 W to a load with a regulated 12 V output, while operating at a duty cycle of 0.8 with continuous inductor current. Following data is given :

(a) The average value of input voltage is given by 15 V

(b) The average value of input voltage is 16 V

(c) The average value of input current is  $4/3$  A

(d) The average value of input current is  $3/4$  A

Which is **correct** out of the following ?

(1) (a), (c)

(2) (b), (c)

(3) (b), (d)

(4) (a), (d)



42. The minority carrier recombination lifetime for an LED is 5 ns. It shows output power of  $300 \mu\text{W}$  at a constant d.c. drive current. Following is the data :

- (a) The output power at 20 MHz is given by  $254.2 \mu\text{W}$
- (b) The output power at 20 MHz is  $90.9 \mu\text{W}$
- (c) The 3 dB Bandwidth of the LED is 55.1 MHz
- (d) The 3 dB Bandwidth is 25.1 MHz

Which is **correct** ?

- (1) (a) and (c)      (2) (b) and (c)      (3) (a) and (d)      (4) only (d)

43. Read the following statements :

- (a) In a J - K Flip Flop, if  $J = K$ , the resulting Flip Flop is referred to as a T - type Flip Flop
- (b) In a J - K Flip Flop, if  $J \neq K$ , the resulting Flip Flop is referred to as a D - type Flip Flop
- (c) An S - R Flip Flop cannot be converted into a T- type Flip Flop since  $S = R = 1$  is not allowed.

Which is **correct** ?

- (1) (a) and (b)      (2) (a) and (c)      (3) (b) and (c)      (4) (a), (b) and (c)

44. Read the following statements :

- (a) Ripple counter is quite often referred as modulo 'n' counter where  $n = 2^N$
- (b) For a modulo "m" counter, the number of flip flops (N) required should satisfy the equation  $m \leq 2^N$
- (c) The minimum number of flip flops (N), required to generate a sequence of length 'S' by a Sequence Generator is given by  $S \geq 2^N - 1$

Which is **correct** ?

- (1) (a) and (b)      (2) (a) and (c)      (3) (b) and (c)      (4) (a), (b) and (c)

45. Read the following statements : (w. r. t. C language)

- (a) A pointer to a function can be passed to another function as an argument.
- (b) One pointer variable can be subtracted from another provided both variables point to the elements of different arrays.
- (c) If a numerical array is defined as a pointer variable, the array elements cannot be assigned initial values.

Which is **correct** ?

- (1) (a) and (b)      (2) (a) and (c)      (3) (b) and (c)      (4) (a), (b) and (c)



46. Read the following statements : (w. r. t. C - Language)
- ST1 : The return statement cannot be used to return an array.
- ST2 : All individual array elements that are not assigned explicit initial values will automatically be set to Zero.
- Which is **correct** ?
- (1) ST1 is True, ST2 is True                      (2) ST1 is True, ST2 is False
- (3) ST1 is False, ST2 is True                    (4) ST1 is False, ST2 is False
47. The baud rate is :
- (a) always equal to the bit transfer rate
- (b) equal to twice the band width of an ideal channel
- (c) equal to the signal rate
- (d) equal to one - half of the bandwidth of an ideal channel
- Which of the above are **correct** answers ?
- (1) (a), (b)                      (2) (b), (c)                      (3) (c), (d)                      (4) (a), (d)
48. Read the following statements :
- (a) A radio receiver always has an RF circuit connected to the antenna terminals.
- (b) The sensitivity of a radio receiver is its ability to amplify weak signals.
- (c) The receivers having an RF stage are superior in performance to the receivers without one, all else being equal.
- Which of the above statements are **correct** ?
- (1) (a) and (b) only                      (2) (b) and (c) only
- (3) (a) and (c)                      (4) All three are correct
49. According to Routh's stability criterion the necessary conditions for the system to be stable are defined as :
- (a) All the coefficients of the characteristics equation should be missing.
- (b) None of the coefficients should be real and should have different sign.
- (c) None of the coefficients of the characteristics equation should be missing or zero.
- (d) All the coefficients should be real and should have the same sign.
- Which of the above statements are **correct** ?
- (1) (b), (c)                      (2) (a), (b)
- (3) (a), (c)                      (4) (c), (d)



50. Read the following statements :

- (a) Whatever the mode of feedback be, the gain after negative feedback is  $\frac{A}{1 + A\beta}$
- (b) A negative feedback reduces the bandwidth of the amplifier.
- (c) A negative feedback increases the output impedance
- (d) A negative feedback enhances the stability of operation

Which of the above statements are **correct** ?

- (1) (a) and (b)      (2) (b) and (c)      (3) (a) and (d)      (4) (b) and (d)

51. In semiconductor, Fermi level lies :

- (a) Close to Valence Band (VB) in p - type
- (b) Close to Conduction Band (CB) in p - type
- (c) Close to Conduction Band in n - type
- (d) Close to Valence Band in n - type

Which is **correct** ?

- (1) (a), (d)      (2) (b), (d)      (3) (a), (c)      (4) (c), (d)

52. Match the following in context of 8255 :

**List - I**

- (a) Mode 0
- (b) Mode 1
- (c) Mode 2

**List - II**

- (i) Strobed I/O mode
- (ii) Bidirectional Bus
- (iii) Basic I/O mode

**Codes :**

- (a)    (b)    (c)
- (1) (ii) (iii) (i)
- (2) (i)    (ii) (iii)
- (3) (iii) (i)    (ii)
- (4) (ii) (i)    (iii)



53. Match the following :

**List - I**

(a) Band Pass Filter

(b) Band Reject Filter

(c) Low Pass Filter

(d) High Pass Filter

**List - II**

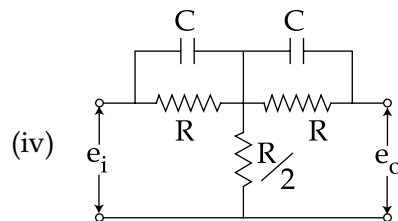
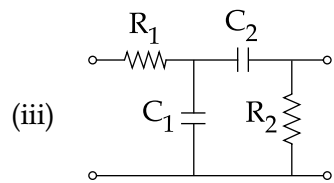
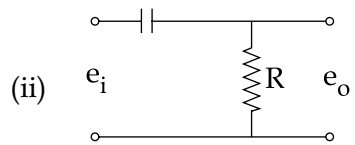
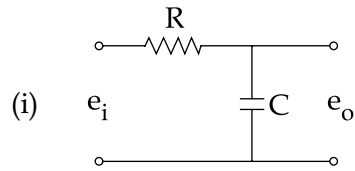

**Codes :**

**(a) (b) (c) (d)**

(1) (iv) (iii) (ii) (i)

(2) (iii) (iv) (i) (ii)

(3) (iv) (iii) (i) (ii)

(4) (iii) (iv) (ii) (i)



54. Match the following :

**List - I**

**List - II**

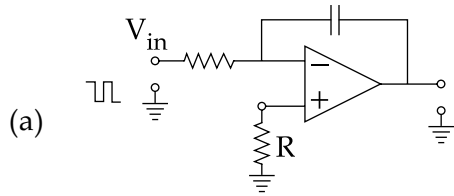

(i) Schmitt trigger circuit

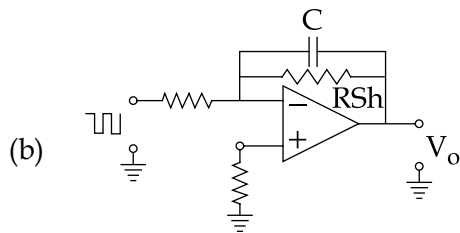

(ii) Triangular wave generator

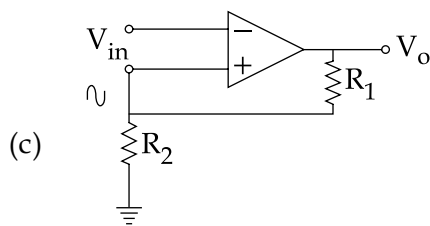

(iii) Subtractor

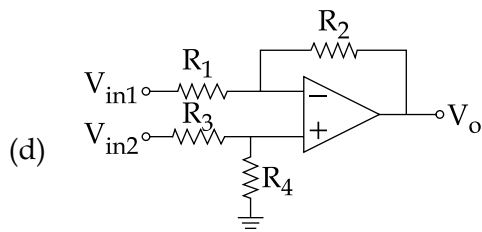

(iv) Integrator circuit

**Codes :**

- |     | (a)  | (b)   | (c)  | (d)   |
|-----|------|-------|------|-------|
| (1) | (iv) | (ii)  | (i)  | (iii) |
| (2) | (iv) | (i)   | (ii) | (iii) |
| (3) | (i)  | (iii) | (ii) | (iv)  |
| (4) | (ii) | (iv)  | (i)  | (iii) |





55. Match the following : (w. r. t. C - Language)

**List - I**

**(Character)**

- (a) carriage return
- (b) bell
- (c) form feed
- (d) horizontal tab

**List - II**

**(Escape Sequence)**

- (i) \f
- (ii) \t
- (iii) \a
- (iv) \r

**Codes :**

- |     | <b>(a)</b> | <b>(b)</b> | <b>(c)</b> | <b>(d)</b> |
|-----|------------|------------|------------|------------|
| (1) | (iv)       | (i)        | (iii)      | (ii)       |
| (2) | (iv)       | (iii)      | (i)        | (ii)       |
| (3) | (iii)      | (iv)       | (ii)       | (i)        |
| (4) | (iii)      | (ii)       | (iv)       | (i)        |

56. Match the following :

**List - I**

- (a) 24C01
- (b) 28C64
- (c) 74S288
- (d) 27C010

**List - II**

- (i) Parallel EPROM
- (ii) EPROM
- (iii) Serial EEPROMS
- (iv) TTL PROM

**Codes :**

- |     | <b>(a)</b> | <b>(b)</b> | <b>(c)</b> | <b>(d)</b> |
|-----|------------|------------|------------|------------|
| (1) | (iii)      | (i)        | (iv)       | (ii)       |
| (2) | (ii)       | (iii)      | (iv)       | (i)        |
| (3) | (iii)      | (iv)       | (i)        | (ii)       |
| (4) | (ii)       | (iv)       | (i)        | (iii)      |



57. Match the following :

**List - I**

- (a) Chopper
- (b) Cycloconverter
- (c) TRIAC
- (d) UJT

**List - II**

- (i) AC motor speed control
- (ii) Fan Regulator
- (iii) DC motor speed control
- (iv) Relaxation oscillator

**Codes :**

- |     | (a)   | (b)  | (c)   | (d)   |
|-----|-------|------|-------|-------|
| (1) | (ii)  | (i)  | (iv)  | (iii) |
| (2) | (iv)  | (ii) | (i)   | (iii) |
| (3) | (iii) | (i)  | (ii)  | (iv)  |
| (4) | (i)   | (ii) | (iii) | (iv)  |

58. Match the following :

**List - I**

- (a) Curl operator
- (b) Del operator
- (c) Divergence theorem
- (d) Stokes theorem

**List - II**

- (i) Gradient
- (ii) Volume to surface conversion
- (iii) Surface to line conversion
- (iv) Rotation

**Codes :**

- |     | (a)   | (b)  | (c)   | (d)   |
|-----|-------|------|-------|-------|
| (1) | (iv)  | (i)  | (ii)  | (iii) |
| (2) | (iv)  | (ii) | (i)   | (iii) |
| (3) | (iii) | (i)  | (ii)  | (iv)  |
| (4) | (i)   | (ii) | (iii) | (iv)  |



59. Match the following :

**List - I**

(a)  $\frac{1}{S}$

(b)  $\frac{1}{S^2}$

(c)  $\frac{ST}{1 + ST}$

(d)  $\frac{1}{S(1 + ST)}$

**List - II**

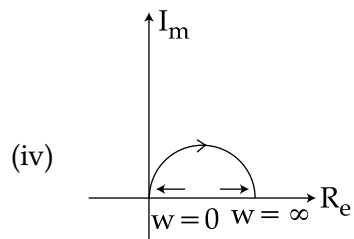
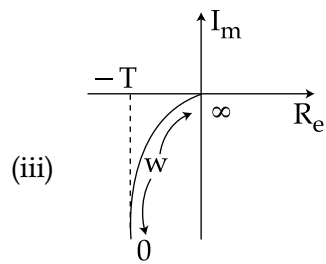
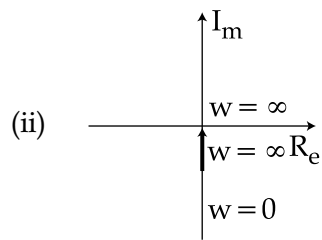
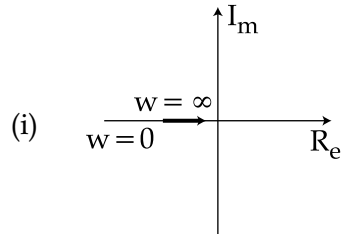

**Codes :**

|     | (a)   | (b)   | (c)   | (d)   |
|-----|-------|-------|-------|-------|
| (1) | (ii)  | (i)   | (iv)  | (iii) |
| (2) | (i)   | (iv)  | (iii) | (ii)  |
| (3) | (iv)  | (iii) | (ii)  | (i)   |
| (4) | (iii) | (ii)  | (i)   | (iv)  |



60. Match the following :

**List - I**

- (a) Cauchy Distribution
- (b) Rayleigh Distribution
- (c) Gamma Distribution
- (d) Uniform Distribution

**List - II**

- (i)  $\frac{x}{a^2} e^{-\frac{x^2}{2a^2}} ; 0 \leq x < \infty$
- (ii)  $\frac{a}{\pi (x^2 + a^2)} ; a > 0$
- (iii)  $\frac{1}{b - a} ; a \leq x \leq b$
- (iv)  $\frac{x^{\alpha-1} e^{-x/\beta}}{\beta^\alpha \Gamma(\alpha)} ; x > 0, \alpha, \beta > 0$

**Codes :**

- |     |            |            |            |            |
|-----|------------|------------|------------|------------|
|     | <b>(a)</b> | <b>(b)</b> | <b>(c)</b> | <b>(d)</b> |
| (1) | (i)        | (ii)       | (iii)      | (iv)       |
| (2) | (iii)      | (iv)       | (i)        | (ii)       |
| (3) | (ii)       | (i)        | (iv)       | (iii)      |
| (4) | (iv)       | (iii)      | (ii)       | (i)        |

Directions for questions 61 to 70 : The following items consists of two statements, one labelled the “**Assertion (A)**” and the other labelled “**Reason (R)**”. You are to examine the two statements carefully and decide if the Assertion (A) and Reason (R) are individually true and if so, whether the reason is a correct explanation of the Assertion. Select your answer to these items using the codes given below and mark your answer accordingly.

**Codes :**

- (1) Both (A) and (R) are true and (R) is the correct explanation of (A)
- (2) Both (A) and (R) are true, but (R) is not the correct explanation of (A)
- (3) (A) is true, but (R) is false
- (4) (A) is false, but (R) is true

61. **Assertion (A) :** E - beam lithography is used for drawing nanostructures.

**Reason (R) :** E- beam lithography has high resolution than photo lithography.



62. **Assertion (A)** : 8086 is 16 - bit processor.  
**Reason (R)** : Physical address of 8086 will be 32 bits.
63. **Assertion (A)** : Any sudden change that might occur in a circuit without an inductor are smoothened out by the presence of an inductor.  
**Reason (R)** : Because the inductor filter depends on the fundamental property to oppose any change of current.
64. **Assertion (A)** : Completion of the design in a transistor requires the check of quiescent-point variations due to temperature changes and unit to unit parameter differences.  
**Reason (R)** : As the principle of operation of the BJT & FET differ, so do the associated methods of Q - point stabilization.
65. **Assertion (A)** : In C - language, a union variable can be initialized provided its storage class is either external or static.  
**Reason (R)** : A union may be a member of structure, but a structure cannot be a member of union.
66. **Assertion (A)** : Flash memory is non-volatile memory that can be electrically erased and reprogrammed.  
**Reason (R)** : Flash memory is a specific type of EEPROM that is erased and programmed, in - circuit, in large blocks in contrast to EEPROM which is erased and reprogrammed at the byte level.
67. **Assertion (A)** : The simplest method to control the speed of an A.C. motor is to vary the applied voltage by using A.C. chopper.  
**Reason (R)** : The voltage can be varied by decreasing or increasing the firing angle.
68. **Assertion (A)** : The wave guides have heavy attenuation for the wavelengths below cut off.  
**Reason (R)** : The wave guides behaves like a high pass filter.



69. **Assertion (A)** : The FM radio broadcast of analog signals provides higher fidelity.

**Reason (R)** : FM uses significantly larger channel bandwidth for signal transmission.

70. **Assertion (A)** : Normally, some standard signal conditioner and display devices are used with a transducer, unless they are custom - built to suit the requirements of the transducers.

**Reason (R)** : A transducer is a device which receives energy in one form and transfer it to a convenient form.

*Read the passage and answer the questions from 71 to 75 that follow based on your understanding of passage :*

The phase locked loop (PLL) is one of the interesting applications of the lock - in amplifier. Apart from FM stereo decoders, tracking filters, motor speed control, FM demodulators, etc. it has found wide applications in generation of local oscillator frequencies in house - hold TV and FM tuners as automatic frequency control (AFC). Indeed, PLL has emerged as one of the fundamental building blocks in electronics and it is commercially available as a single package. Basically, a PLL is a lock - in amplifier in which the reference signal is provided by its own output, converted to frequency by a voltage controlled oscillator (VCO). When locked to the input frequency the dc output is small but sufficient to drive the VCO to produce a frequency which is equal to that of the signal. In this tracking situation, the input signal and the VCO output are almost in phase quadrature and the lock-in amplifier produces a small dc voltage which is often referred to as error voltage. The moment input signal is fed, the VCO frequency starts changing and the PLL is said to be in the capture mode. The VCO continues to change its frequency until it equals that of the input and stays there ; the PLL is then in the phase - locked state. In this state, if there is any change in the input frequency, the loop automatically tracks it through its repetitive action.

71. The voltage controlled oscillator is used for :

- (1) Voltage to frequency conversion    (2) Frequency to voltage conversion  
(3) Voltage to voltage conversion    (4) Frequency to frequency conversion

72. The PLL is in the free - running state when :

- (1) Input applied is equal to output voltage.  
(2) Input is twice of the output voltage.  
(3) Input is one half of the output.  
(4) No input is applied.



73. A phase locked loop (PLL) consists of :
- (1) A high pass filter
  - (2) A band pass filter
  - (3) A low pass filter
  - (4) An all pass filter
74. A PLL is used for demodulation of which of the following signals ?
- (1) Amplitude modulated signals
  - (2) Frequency modulated signals
  - (3) Pulse code modulated signals
  - (4) FSK signals
75. The sample and hold devices are used to perform :
- (1) Frequency - division - multiplexing
  - (2) Frequency modulation
  - (3) Time - division - multiplexing
  - (4) Amplitude modulation

- o 0 o -



**Space For Rough Work**

